

# LPE-7-27

Low Profile LTE

03/06/2015 v.1

## Low Profile 2G/3G/4G Antenna

Rugged Low Profile Design  
Wideband LTE-Cellular Element  
Weatherproof Casing



The LPE antenna series is a range of low profile antennas incorporating a combination of wideband cellular elements covering 2G/3G and 4G frequencies in a robust compact housing.

Designed to be tough yet cost effective, the antennas are completely enclosed in a moulded housing made from weather and impact resistant plastic. The range is supplied with short fly leads and can be kitted with Panorama Antennas' low loss extension cables in various lengths.

### Technical Drawing

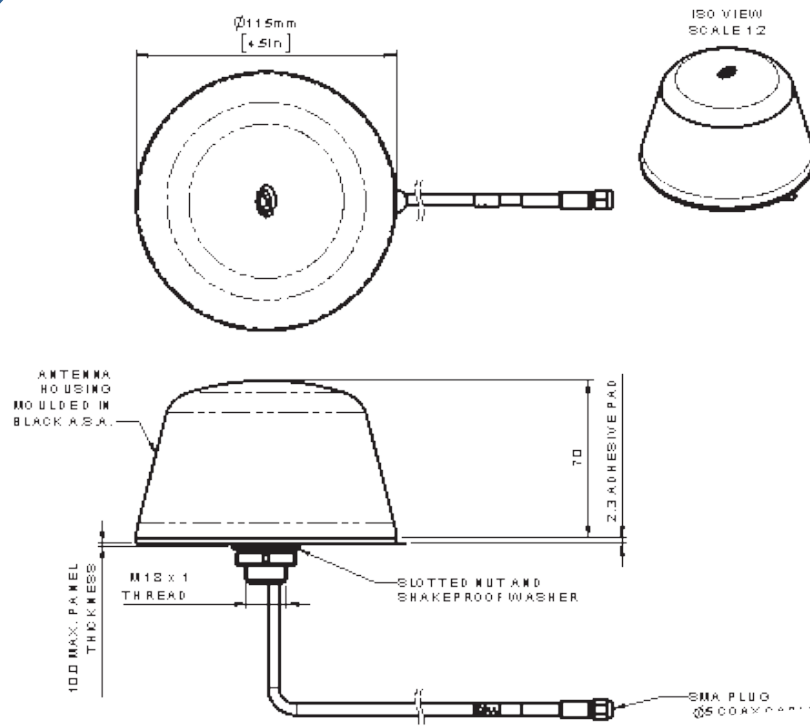

**PANORAMA ANTENNAS**  
Panorama Antennas Ltd  
Frogmore, London, SW18 1HF, United Kingdom

T: +44 (0)20 8877 4444  
F: +44 (0)20 8877 4477  
E: sales@panorama-antennas.com  
www.panorama-antennas.com

Waiver: The data given above is indicative of the performance of the product/s under particular conditions and does not imply a guarantee of performance. These specifications are subject to change without notice.

Copyright © Panorama Antennas Ltd. All rights reserved.

## Part No.

LPE-7-27

## Electrical Data

Frequency Range (MHz)	Element 1	698-960 / 1700-2700
Operational Bands	Element 1	LTE / Cellular
Peak Gain: Isotropic	Element 1	698-960MHz
		1710-2700MHz
Typical VSWR	Element 1	≤ 2.5:1
Polarisation		Vertical
Impedance		50Ω
Max Input Power (W)		50

## Mechanical Data

Dimensions	Height	2.8" (70mm)
	Diameter	4.5" (115mm)
Operating Temp		-22° / 176°F (-30° / +80°C)
Material		A.S.A
Colour		Black

## Mounting Data

Mounting type	Panel mount
Max panel thickness	0.4" (10mm)
Mounting hole	3/4" (19mm)

## Cable Data

Cell / LTE Cable	Type	CS29 (double shielded RG58)
	Diameter	0.2" (5mm)
	Length	1' (0.3m)
	Termination	SMA (male)

We recommend the customer uses Panorama CS29 extension cables for 2G/3G/4G, CS32 extension cables for WLAN and RG174 or CS23 for GPS.

Typical VSWR cellular / LTE element 1\*

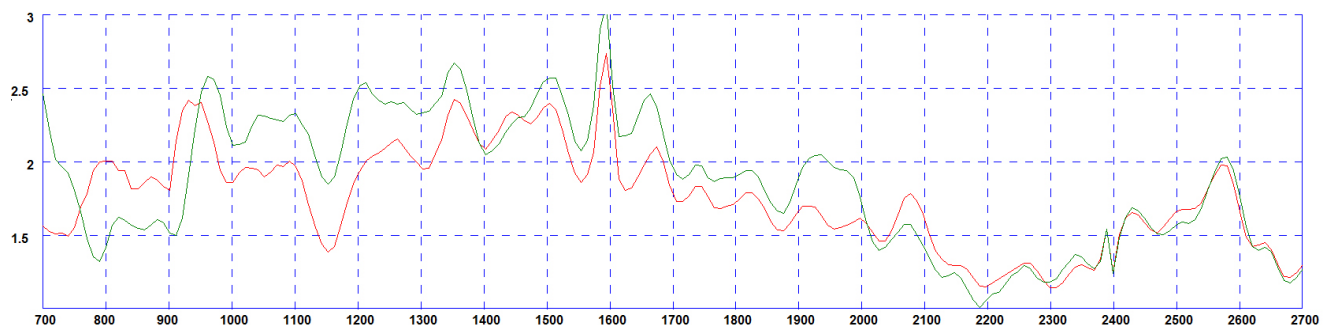

\* Red VSWR measured in on a 400x400mm (1.3' x 1.3') ground plane without extension cables.  
Green VSWR measured in free space without extension cables.

Product Data

Typical 3D Pattern - Element 2 700MHz

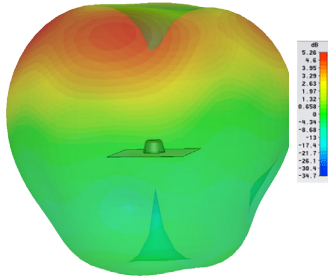

Typical 3D Pattern - Element 2 800MHz

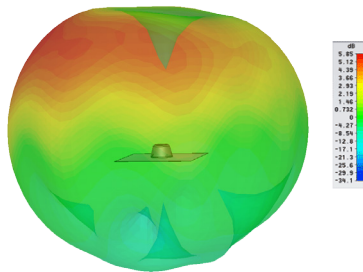

Typical 3D Pattern - Element 2 900MHz

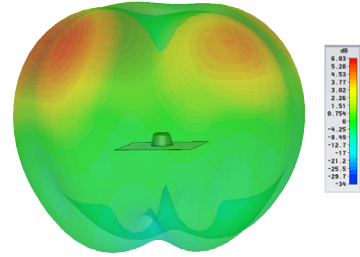

Typical 3D Pattern - Element 2 1800MHz

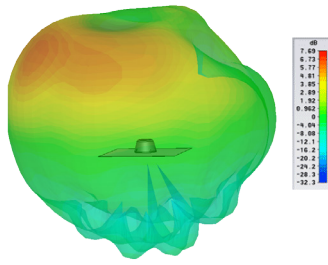

Typical 3D Pattern - Element 2 2000MHz

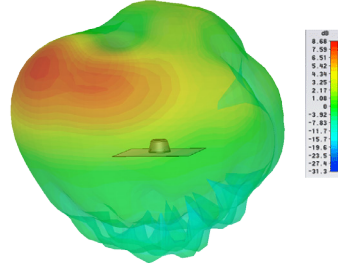

Typical 3D Pattern - Element 2 2600MHz

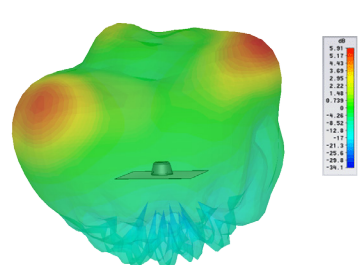

Typical H-Plane (700MHz)

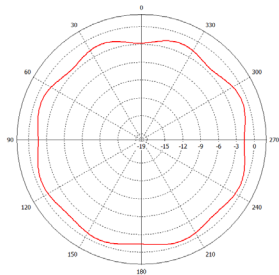

Typical H-Plane (800MHz)

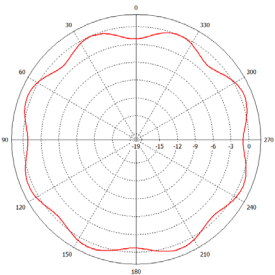

Typical H-Plane (900MHz)

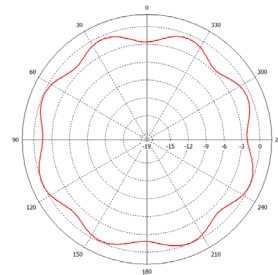

Typical H-Plane (1.7GHz)

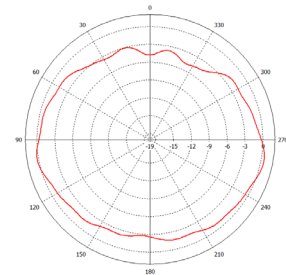

Typical H-Plane (1.9GHz)

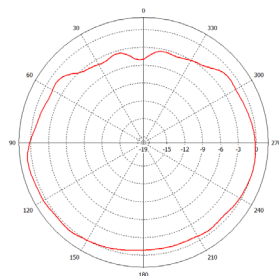

Typical H-Plane (2.7GHz)

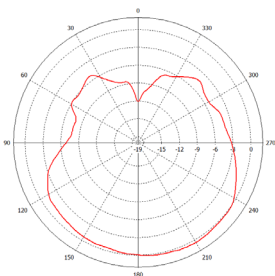

All pattern and gain measurements taken on a 400 x 400mm (2' x 2') ground plane without additional cable.

**Panorama Antennas Ltd**

Frogmore, London, SW18 1HF, United Kingdom

T: +44 (0)20 8877 4444

F: +44 (0)20 8877 4477

E: [sales@panorama-antennas.com](mailto:sales@panorama-antennas.com)

[www.panorama-antennas.com](http://www.panorama-antennas.com)

Waiver: The data given above is indicative of the performance of the product/s under particular conditions and does not imply a guarantee of performance. These specifications are subject to change without notice.

Copyright © Panorama Antennas Ltd. All rights reserved.

*PANORAMA*  *ANTENNAS*